

Montagevejledning

Låg til plantekasse

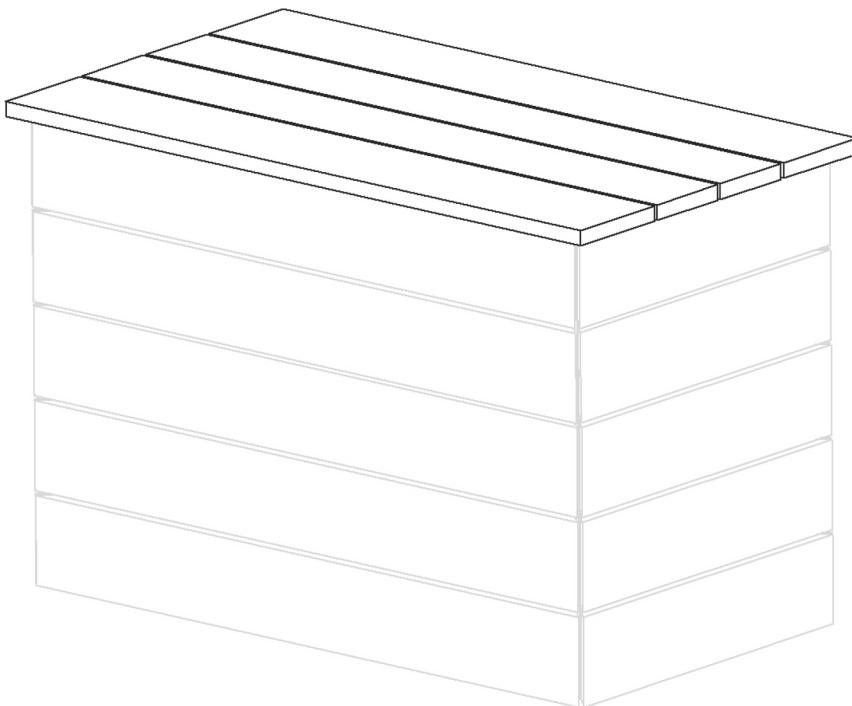

Det skal du bruge

Skruemaskine

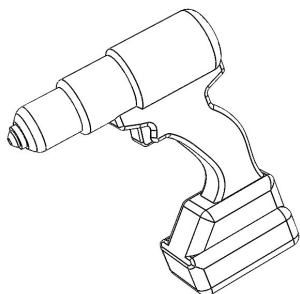

Bit TX20

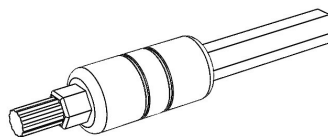



Bor

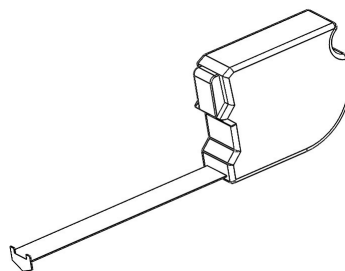

Målebånd

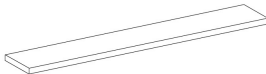
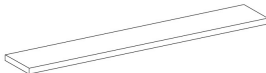

Dele du skal bruge

	
	2 stk. smalle brædder
	
	2 stk. bredde brædder
	
	4 stk. tværbrædder
	
	3 stk. pose å 10 træskruer

Montering - step 1

Det kan være en fordel at forbore montagelisterne for at undgå, at brædderne og montagelisten forskydes under montage.

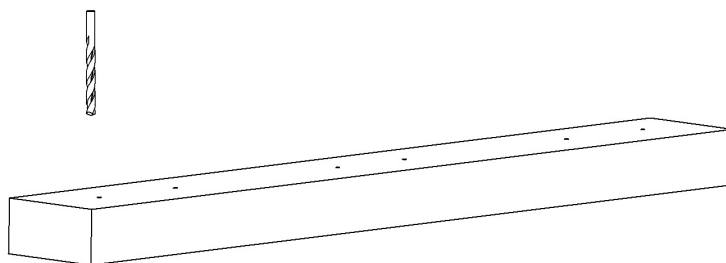
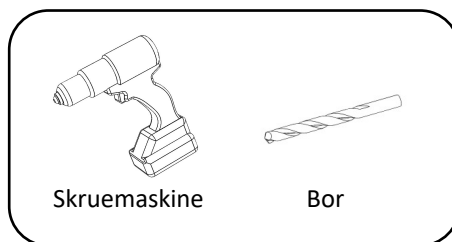

Montering – step 2

Læg brædderne ud til montage med 5mm mellemrum mellem brædderne
Placer de to bredde brædder yderst.

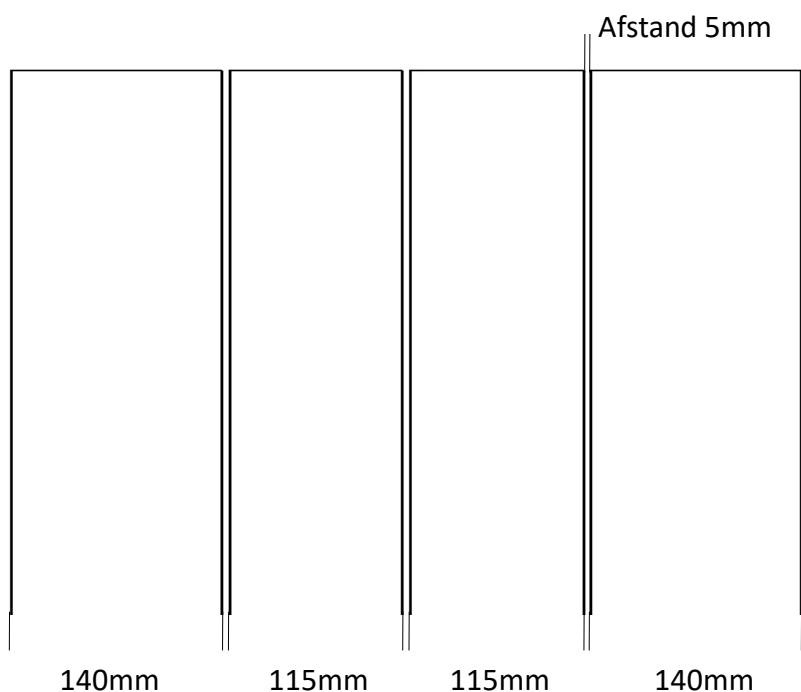
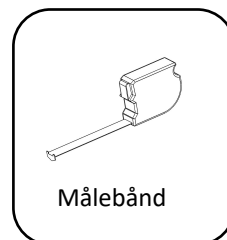

Montering - step 3

Monter de forborede tværbrædder, for at samle låget

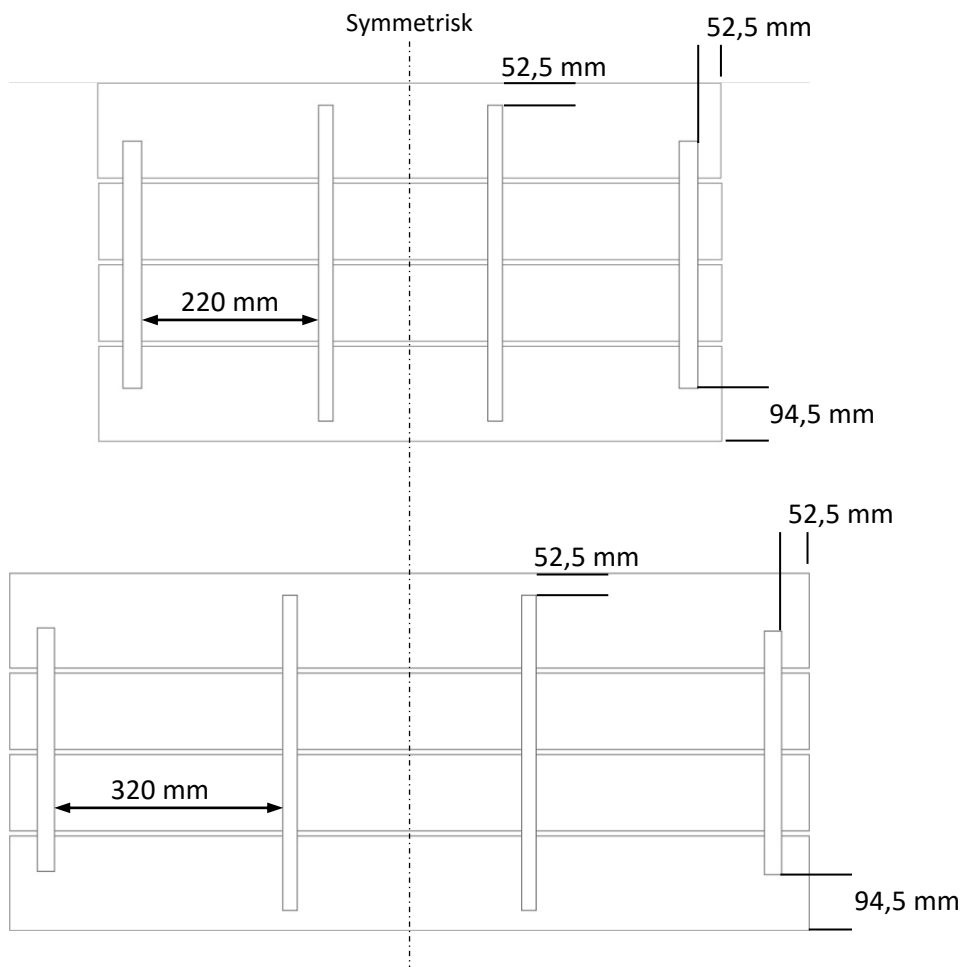
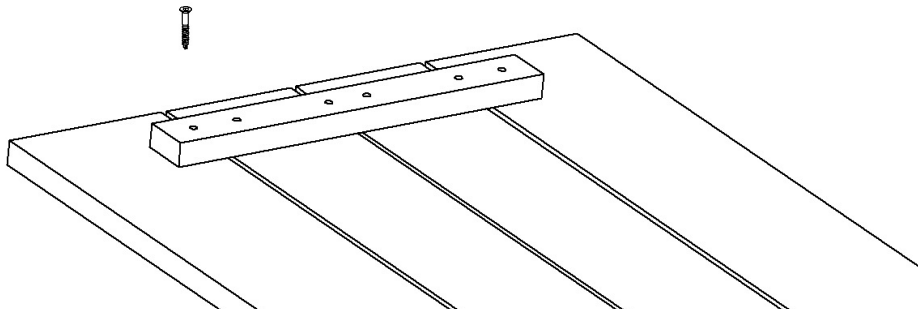
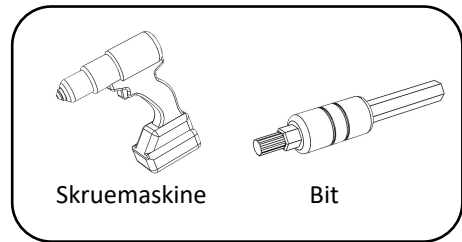

Vedligehold

De fleste af vores produkter kræver hver især meget lidt vedligehold. Det er dog vigtigt at sørge for at rengøre overfladerne regelmæssigt. Da produkterne oftest er placeret udendørs, skal du forvente, at der kan sætte sig snavs, alger og lignende, som bør vaskes af.

Benyt gerne Wimex Trærens til vedligeholdelse.

Se mere information på www.wimex.dk - Plejevejledning

