

Montagevejledning

Stolpe med lys

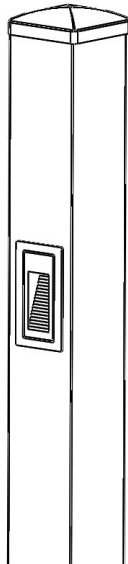

Det skal du bruge

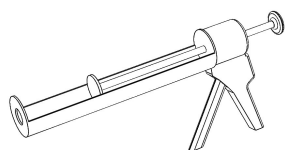

Fugepistol

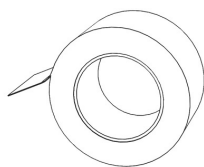

Tape

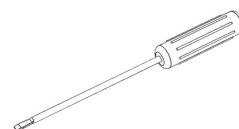

Værktøj til montage af el.
Det anbefales at benytte
en el-installatør.

1 stk. stolpe med lys

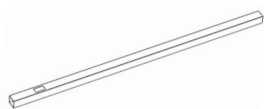

1 stk. stolpe

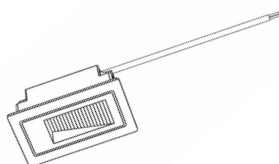

1 stk. lyskilde

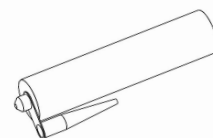

1 stk. montagelim



1 stk. stolpehat

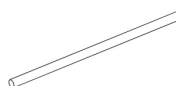

1 stk. stolpeanker

Udgravning og støbning

Benyt beton eller tørbeton til nedstøbning.

Spade

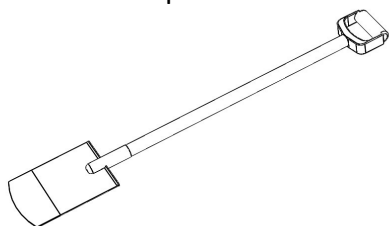

Pælebor min. Ø250 mm

eller

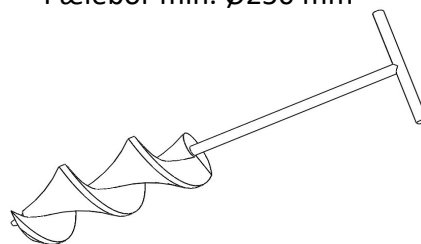

1. Nedstøbning og kabelføring

Det anbefales at kontakte en el-installatør for vejledning om kabel og kabelføring. Støb et kabel eller et kabelrør ned sammen med stolpen.

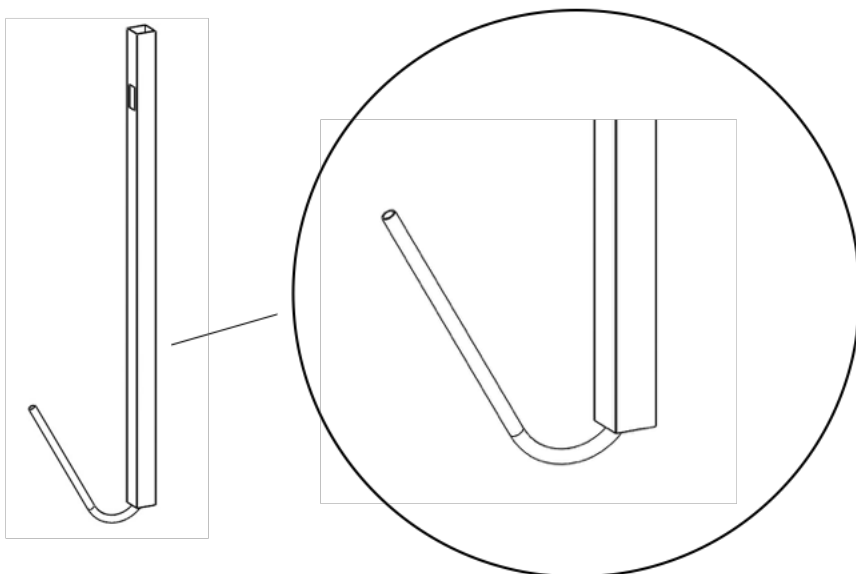

Nedstøb eventuelt kabelrør for senere kabelføring.

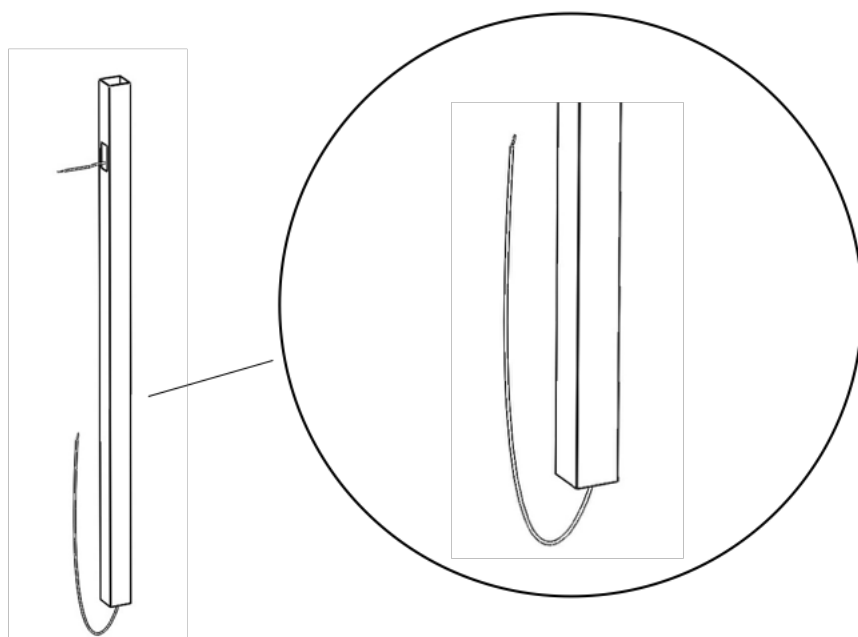

Nedstøb eventuelt et kabel. Husk at føre det helt op til hullet ved lyskilden.

1. Stolpeanker

For information om nedstøbning og afstande mellem stolperne se Wimex montagevejledning til hegn.

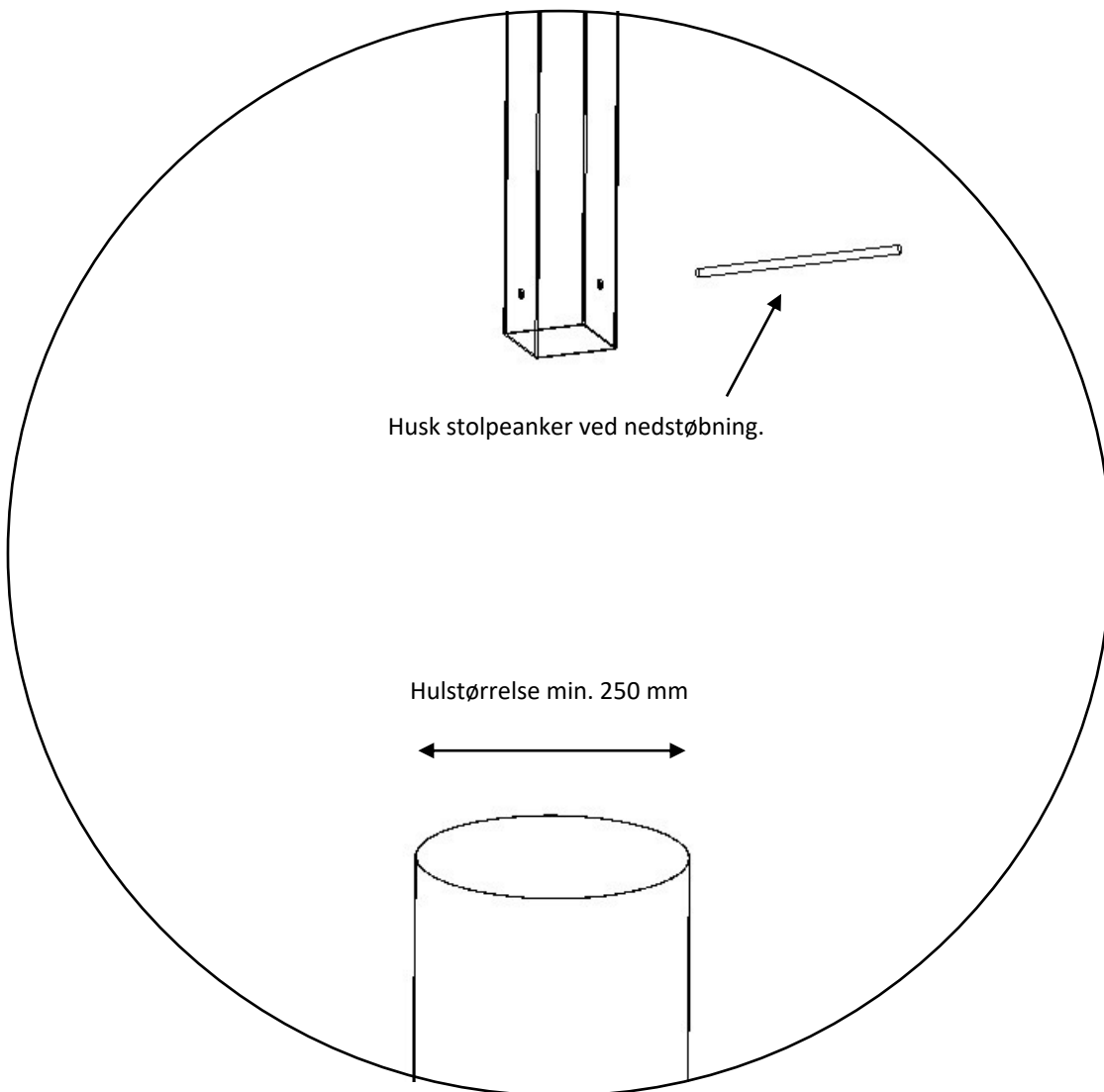
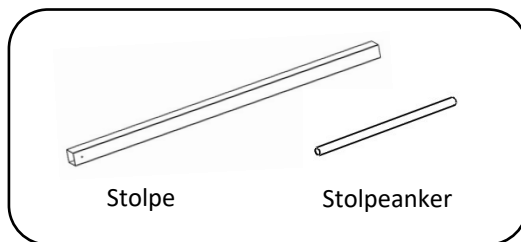

2. Lyskilde

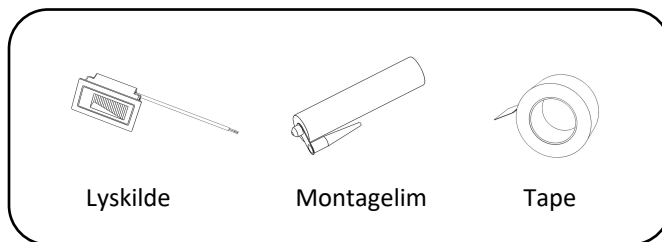

OBS!

Fjern plastindstøbningskassen fra lyskilden.
Denne plastkasse skal ikke benyttes.

Tilslut lyskildens ledning.

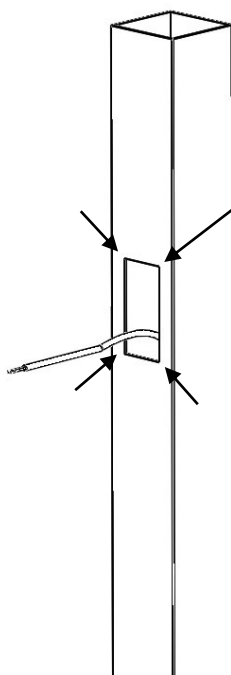

Lidt montagelim i hvert hjørne.
Lim ikke på fugtigt materiale.

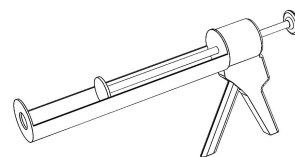

Fugepistol

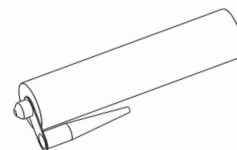

Montagelim

3. Montage af lyskilde

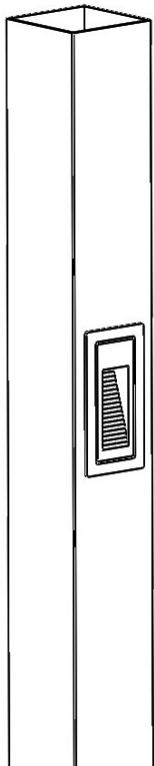

Pres lyskilden ind i montagelimen

Ret lyskilden til så den sidder pænt, lige og centreret i stolpen.
Fasthold lyskilden med tape til limen er hærdet op.
Fjern eventuelt overskydende montagelim.

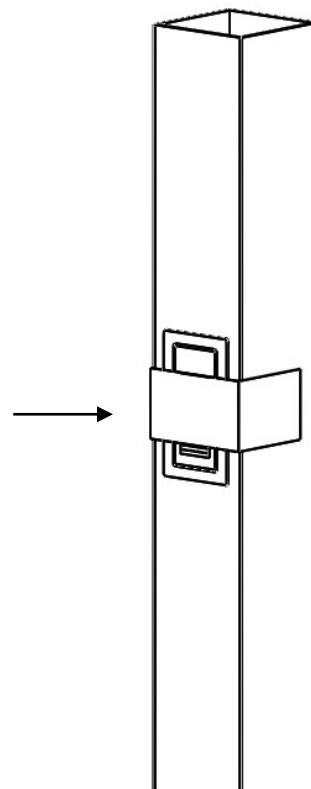

4. Stolpehat

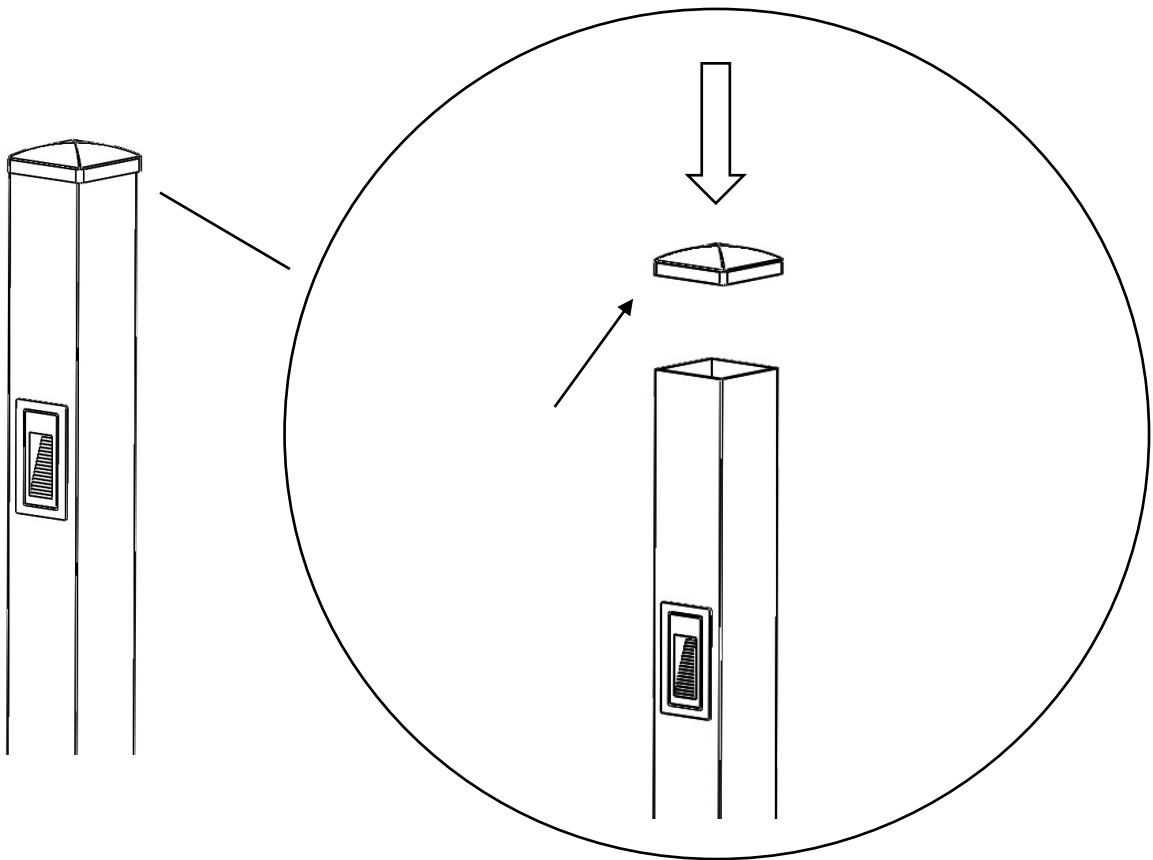
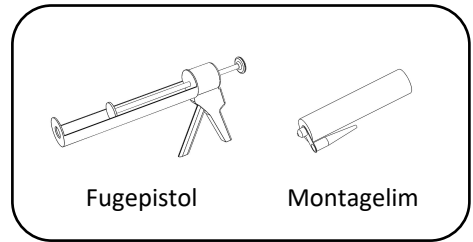

Monteres med montagelim.
Limes i hvert hjørne.
Lim ikke på fugtigt materiale.



Se mere information på

www.wimex.dk